



Bump Style Autofacer

Operating Instructions

STEINER

Thank you for investing in a Steiner Autofacer

If this is your first experience with an Autofacer, you'll discover this is a truly ingenious tool that allows you to reach through a hole and machine a circular feature on the back side of a workpiece automatically; circular features such as a spotface, counterbore, countersink, chamfer, spherical radius, or some combination thereof.

This is accomplished by mechanically folding the cutting blade into the body of the Autofacer allowing the tool to pass through the workpiece. Once the tool has passed through the workpiece the cutting blade is mechanically opened and reverse machining may begin.

The key design features of the Autofacer are:

1. Friction clutch that mechanically opens and closes the cutting blade ensuring high reliability of part processing.
2. Cutting blades that are mechanically held open while cutting allows the Autofacer to perform heavy interrupted cuts.
3. Autofacer Cutter Body or Rotary Pilot utilizes the workpiece hole to support the tool while cutting. This enables the operator to run the Autofacer at high speeds and feeds even at long length-to-diameter ratios.

Autofacer cutting blades are available in many different configurations depending upon customers' applications. Having a full service grind department at our manufacturing facility in the New York allows us to offer custom geometries on our indexable inserts and brazed carbide Cutter Blades. This means we can combine multiple operations into a single blade, thus maximizing time savings.

The Application Engineers at Steiner will select the appropriate activation method to ensure optimum performance. Backed by more than 50 years experience, we are here to serve your most demanding needs.



Get to know your Autofacer



1. **Pivot Pin** - Locking Pin which connects cutter blade or master holder to Activating rod.
2. **Cutter Blade** - Available in many configurations including indexable inserts and brazed carbide.
3. **Activating Rod** - Transfers rotational forces from the clutch to the cutting blade.
4. **Pilot** - Custom manufactured to suit individual applications. Allows the tool to run at carbide speeds and feeds, and in long length-to-diameter applications.
5. **Activating Cone** - Spring loaded tapered cone that grips the face of the workpiece when compressed and transfers rotation from the machine spindle into the Autofacer Clutch.
6. **Shear Pin** - Brass pin located in the Shank of the Autofacer which is designed to break in the event of axial overload.

Things to check before operating:

1. Manually open and close the Autofacer. Check for smooth activation with no obvious signs of bindings
2. Is the cutting blade locked securely onto the flat of the Pivot Pin?

Programming and Operating Hints

1. Turn ON the spindle through coolant after blade has opened.
2. Turn OFF the spindle through coolant before blade has closed.
3. Autofacers utilizing a Shear Pin must clear the work piece by a minimum of 3 inches before traversing. This will allow the shank to completely pull off the Cutter Body in case the Shear Pin breaks.

Cutter Installation Instructions:

1. Insert the pivot pin into the cutter body and thru the blade. Rotate the pivot pin until it engages the tang of the activating rod.
2. With the blade in the open position, rotate the clutch of the tool until the alignment mark on the pivot pin is parallel to the hex wrench and set screw in the cutter blade. This will ensure the set screw is aligned with the flat on the pivot pin.
3. Apply a small amount of serviceable Loctite (provided) to threads of screw. Tighten set screw to 6-10 in/lbs., being careful not to overtighten and ensuring set screw is on flat of pivot pin. If second follow up screw is provided, install and tighten to 6 in/lbs.

TIP: To verify the set screw is located on the flat of the pivot pin, loosen set screw slightly and attempt to pull pivot pin out of tool. The pin should only be able to slide until the set screw stops on the end of the pivot pin flat.

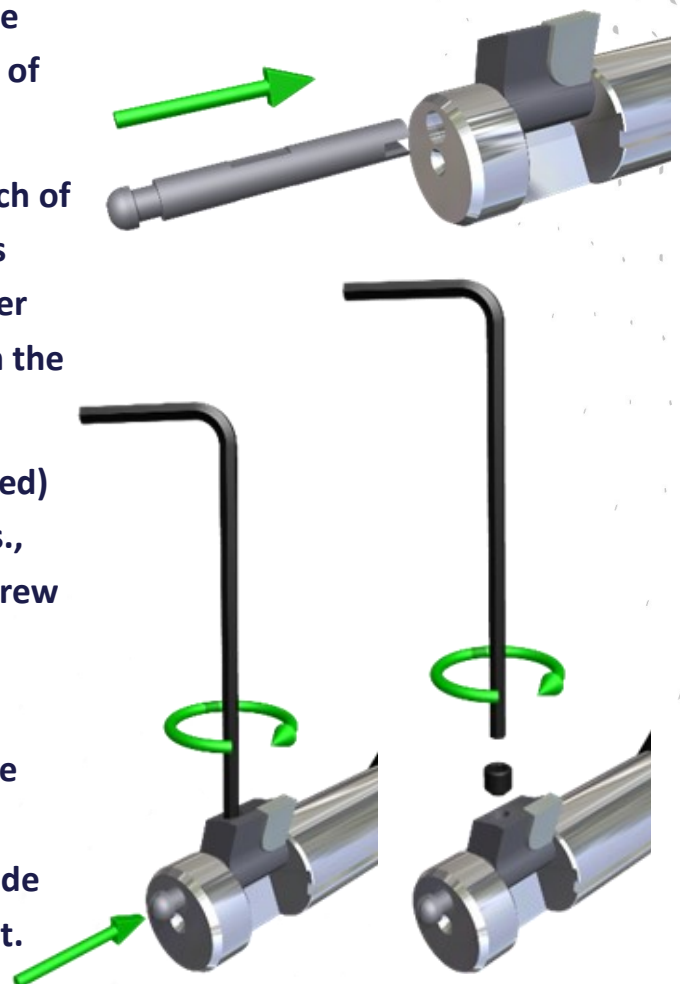

Cone Activated Autofacer Sequence

1.

With through coolant **OFF** and flood coolant **ON**, enter work hole in clockwise rotation at 100 rpm until tapered Activating Cone contacts part.

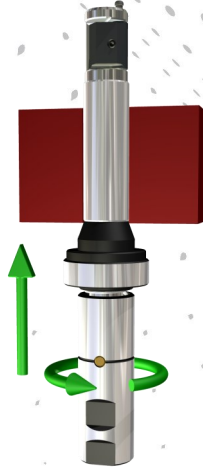

2.

Compress Activating Cone .060" (1.5mm). Reverse spindle to counter-clockwise. Cone will grip face of part and blade will open.

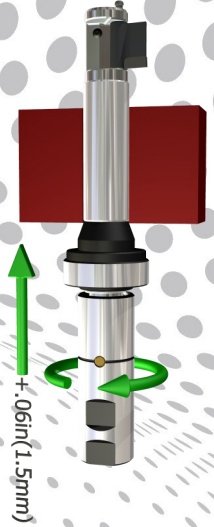

3.

After 1-3 revolution dwell, feed off of activating cone and increase rpm to proper cutting speed. Turn through coolant **ON**.

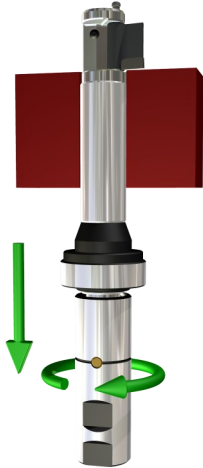

4.

Feed back to counterbore depth. Dwell for 1-3 revolutions to clean up cut.

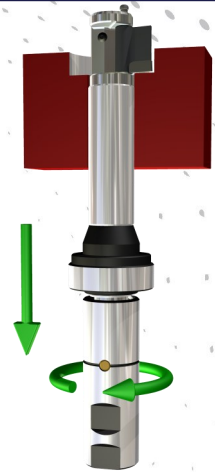

5.

Drop to 100 rpm. Turn through coolant **OFF**, fast feed forward to contact Activating Cone and depress .060-.080" (1.5mm). Reverse spindle to 100 rpm clockwise. Cone will grip face of part and blade will close.

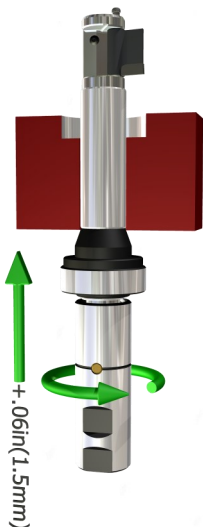

6.

At 100 rpm clockwise, fast feed out of the part to complete machining cycle.

*Feed out until the end of the tool is at least 3" above your workpiece before making a X or Y movement.

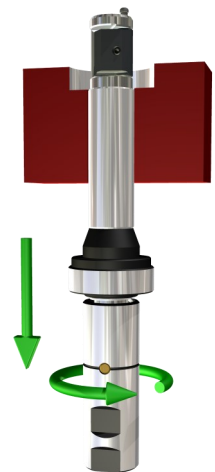

Autofacer Maintenance Information

Lubrication:

If through spindle coolant is being used, lubrication is not necessary for the operation of the tool. If through spindle coolant is not being used, the clutch components of the Autofacer should be lubricated after every 10 hours of use.

Lubricate by disassembling the tool and applying lubricant to flywheel clutch and pilot assemblies.

If the tool has not been in use for an extended period of time, lubricate before using with marine grease.

If the tool will not be in use for an extended period of time, make sure to clean and lubricate thoroughly with rust inhibitor and seal within an airtight bag before putting away.

Inspection & Maintenance:

The Autofacer should be inspected for wear and tear monthly or sooner depending on usage.

It is a good idea to activate the tool by hand periodically to check for a smooth activation and no noticeable binding.

Periodically inspect the Cutter Body pocket for chips that may prevent to the tool from closing fully.

After use, disassemble the Autofacer and inspect the components of the clutch mechanism for any signs of damage or wear. Replace as necessary.



Troubleshooting

The Shear Pin is breaking during machining:

- This is caused when cutting pressure is too high due to too high of a feed rate or a dull Cutter Blade or Insert. First, check the cutting edge to see if it needs sharpening or replacing. If not, decrease the feed rate by 10-20%.

The Shear Pin is breaking when exiting the part:

- This is caused when the blade has not closed. First check that the Cutter is properly attached to the Pivot Pin. Next disassemble the tool and check the activating rod for wear or damage.

The chip is not breaking:

- This is usually caused by too low of a feed rate. Autofacers are designed to be fed at high feed rates. Increase the feed rate by 10-20%.
- Program periodic dwells into the feed to thin the chip out.

The Cutter is coming loose from the Pivot Pin:

- Apply a small drop of serviceable Loctite (provided with purchase of an Autofacer) to the thread of the secondary lock screw.
- The blade may not be locked onto the flat of the Pivot Pin.
Please see "Cutter Installation Instructions."

The Cutter is not opening or closing all the way:

- The blade may not be locked onto the flat of the Pivot Pin.
Please see "Cutter Installation Instructions."
- The tool may be jammed up by chips. Make sure there are no chips in the Cutter Body pocket where the blade folds into. Also, disassemble the Autofacer and check for chips or damage to the internal components of the clutch mechanism.

The tool is chattering:

- This is usually caused by too low of a feed rate. Autofacers are designed to be fed at high feed rates. Increase the feed rate by .001-.003 IPR (.03-.08 MMPR).
- The clearance between the Pilot and the work hole may be too great. The diameters should differ no more than .010" (.25mm) but no less than .002" (.05mm).