

4

3

2

1

REVISIONS				
ZONE	REV.	DESCRIPTION	DATE	APPROVED
	A	RELEASED	1/20	M.Hoyt

C

C

B

B

A

A

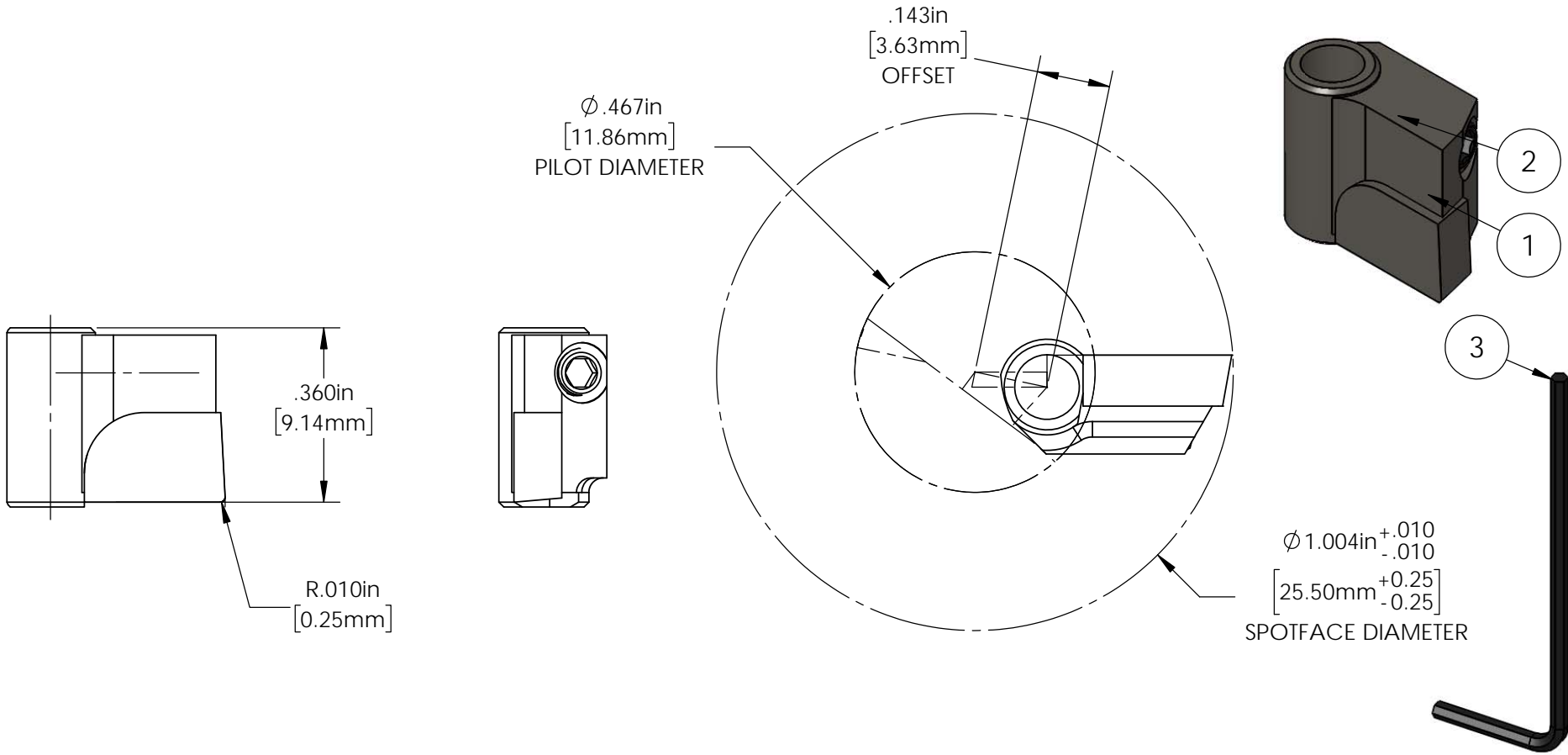

ITEM NO.	PART NUMBER	DESCRIPTION	QTY.
1	2037	CUTTER BLADE BLANK	1
2	029-083	SOCKET SET SCREW, M3 X 0.5 X 3	2
3	031-15M	HEX ALLEN WRENCH, 1.5mm	1
4	2040	CARBIDE BLANK	1

CARBIDE: **MG**
 COATING: **NONE**

THIS DRAWING IS THE CONFIDENTIAL AND EXCLUSIVE PROPERTY OF STEINER TECHNOLOGIES, INC. AND MAY NOT BE COPIED, REPRODUCED, OR DISCLOSED IN ANY WAY, WHATSOEVER TO ANYONE WITHOUT THE EXPRESS WRITTEN PERMISSION OF R. STEINER TECHNOLOGIES, INC. UNLAWFUL DISCLOSURE MAY RESULT IN PROSECUTION

UNLESS OTHERWISE SPECIFIED DIMENSIONS ARE IN INCHES
 TOLERANCES UNLESS SPECIFIED
 XX ±0.020 XXX ±0.005 ANGLES ±0.5°
 XXX ±0.010 XXXXX ±0.0005
 INTERPRET TO ASME Y14.5M-1994

DRAWN BY: M.Hoyt
 DWG DATE: 1/15/2020
 ENDUSER: Steiner
 FINISH: NONE
 MATERIAL: 4140
 HT:

STEINER
 Steiner Technologies, Inc.
 180 Perinton Pkwy
 Fairport, NY 14450
 (P) 888-327-1949
 TITLE:
 CUTTER BLADE Ø25.5 +0.25/-0.25

SCALE 5:1 DWG SIZE A REV. A
 SHEET: 2 OF 2
 DRAWING NO.
CB47-25.50M

4

3

2

1