

4

3

2

1

REVISIONS				
ZONE	REV.	DESCRIPTION	DATE	APPROVED
	A	RELEASED	1/20	M.Hoyt

C

C

B

B

A

A

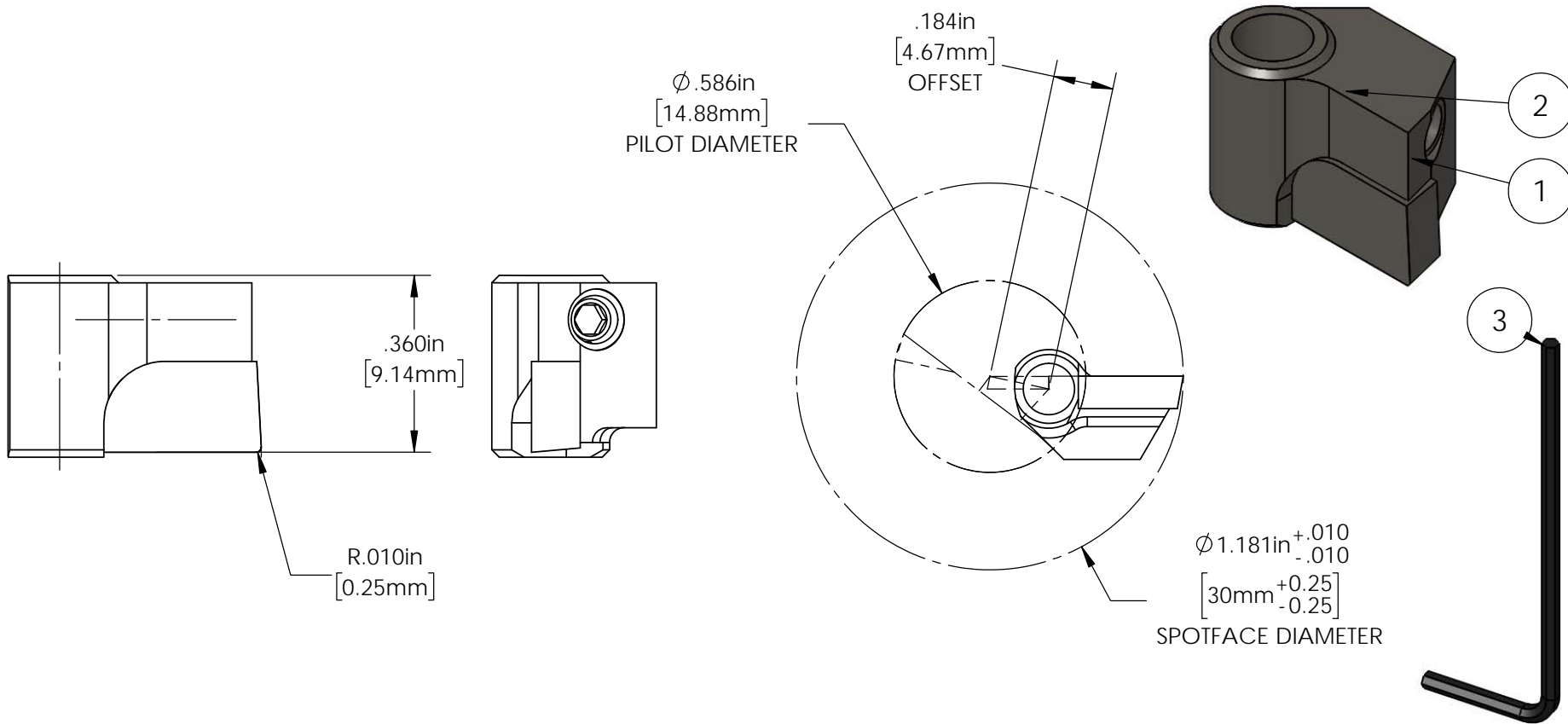

ITEM NO.	PART NUMBER	DESCRIPTION	QTY.
1	2050	CUTTER BLADE BLANK	1
2	029-083	SOCKET SET SCREW, M3 X 0.5 X 3	2
3	031-15M	HEX ALLEN WRENCH, 1.5mm	1
4	2050	CARBIDE BLANK	1

CARBIDE: **MG**
 COATING: **NONE**

THIS DRAWING IS THE CONFIDENTIAL AND EXCLUSIVE PROPERTY OF STEINER TECHNOLOGIES, INC. AND MAY NOT BE COPIED, REPRODUCED, OR DISCLOSED IN ANY WAY, WHATSOEVER TO ANYONE WITHOUT THE EXPRESS WRITTEN PERMISSION OF R. STEINER TECHNOLOGIES, INC. UNLAWFUL DISCLOSURE MAY RESULT IN PROSECUTION

UNLESS OTHERWISE SPECIFIED DIMENSIONS ARE IN INCHES

TOLERANCES UNLESS SPECIFIED
 XX ±0.020 XXX ±0.005 ANGLES ±0.5°
 XXX ±0.010 XXXX ±0.0005

INTERPRET TO ASME Y14.5M-1994



DRAWN BY: M.Hoyt
 DWG DATE: 1/15/2020

ENDUSER: Steiner
 FINISH: NONE

MATERIAL: 4140
 HT:



STEINER

Steiner Technologies, Inc.
 180 Perinton Pkwy
 Fairport, NY 14450
 (P) 888-327-1949

TITLE:
 CUTTER BLADE 30 +0.25/-0.25

SCALE 5:1
 DWG SIZE A
 SHEET: 2 OF 2

REV.
 A

DRAWING NO.
 CB59-30.00M

4

3

2

1